

REVISIONS				
ZONE	LTR	DESCRIPTION	DATE	APPROVED

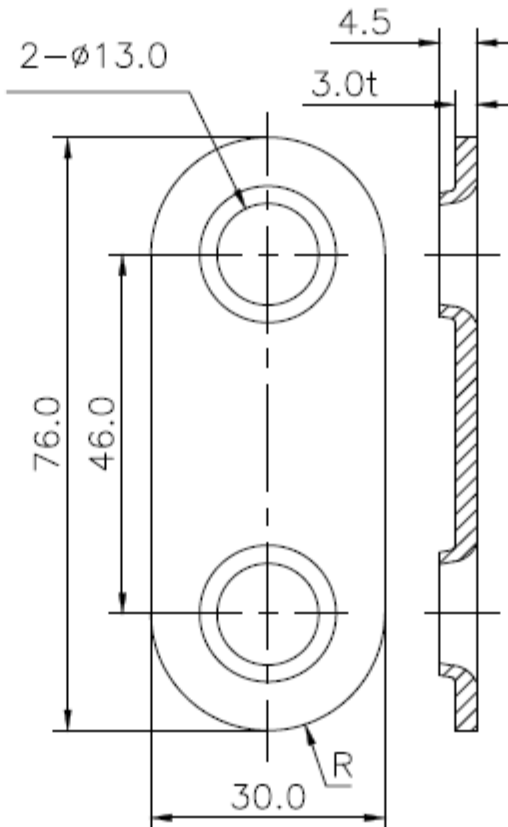

WELDED PLATE

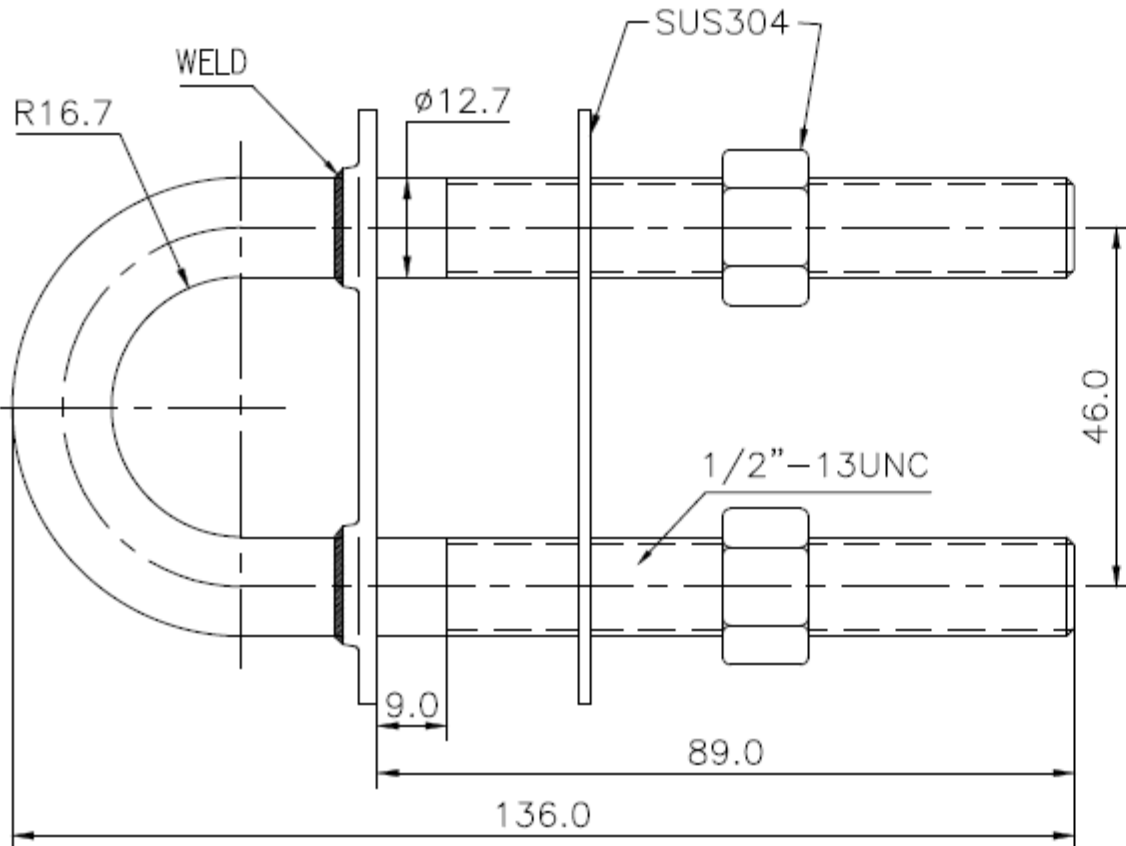
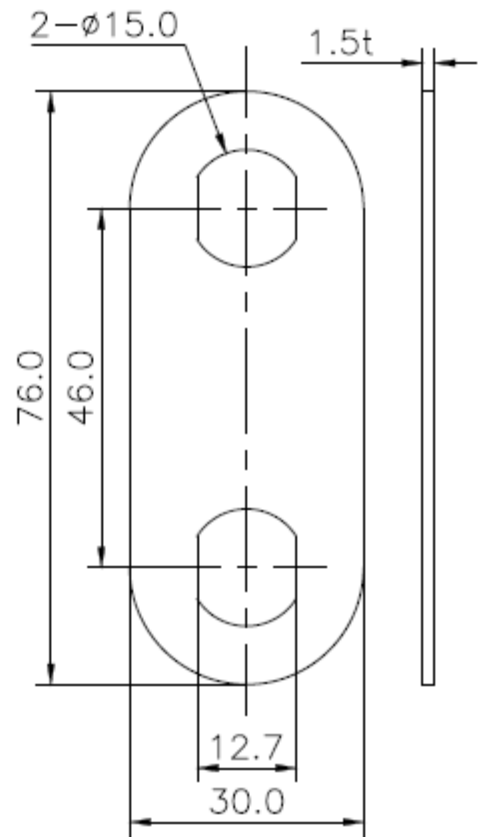

BACK PLATE

SUS304 OSC P/N:3912706